

Application Description

These Cutler-Hammer® ampere and horsepower rated devices from Eaton's electrical business are designed for service in applications such as Refrigeration, Air Conditioning and Resistance Heating and are manufactured to traditional Cutler-Hammer standards for quality and reliability. They are subjected to stringent quality assurance inspections and

testing procedures. The life expectancy, both electrical and mechanical, will meet or exceed industry performance requirements for Definite Purpose devices.

If more detailed technical information is required — specifications, ratings, etc. — contact your local Eaton distributor or sales office.

Catalog Number Selection

Table 1. Definite Purpose Control Catalog Numbering System

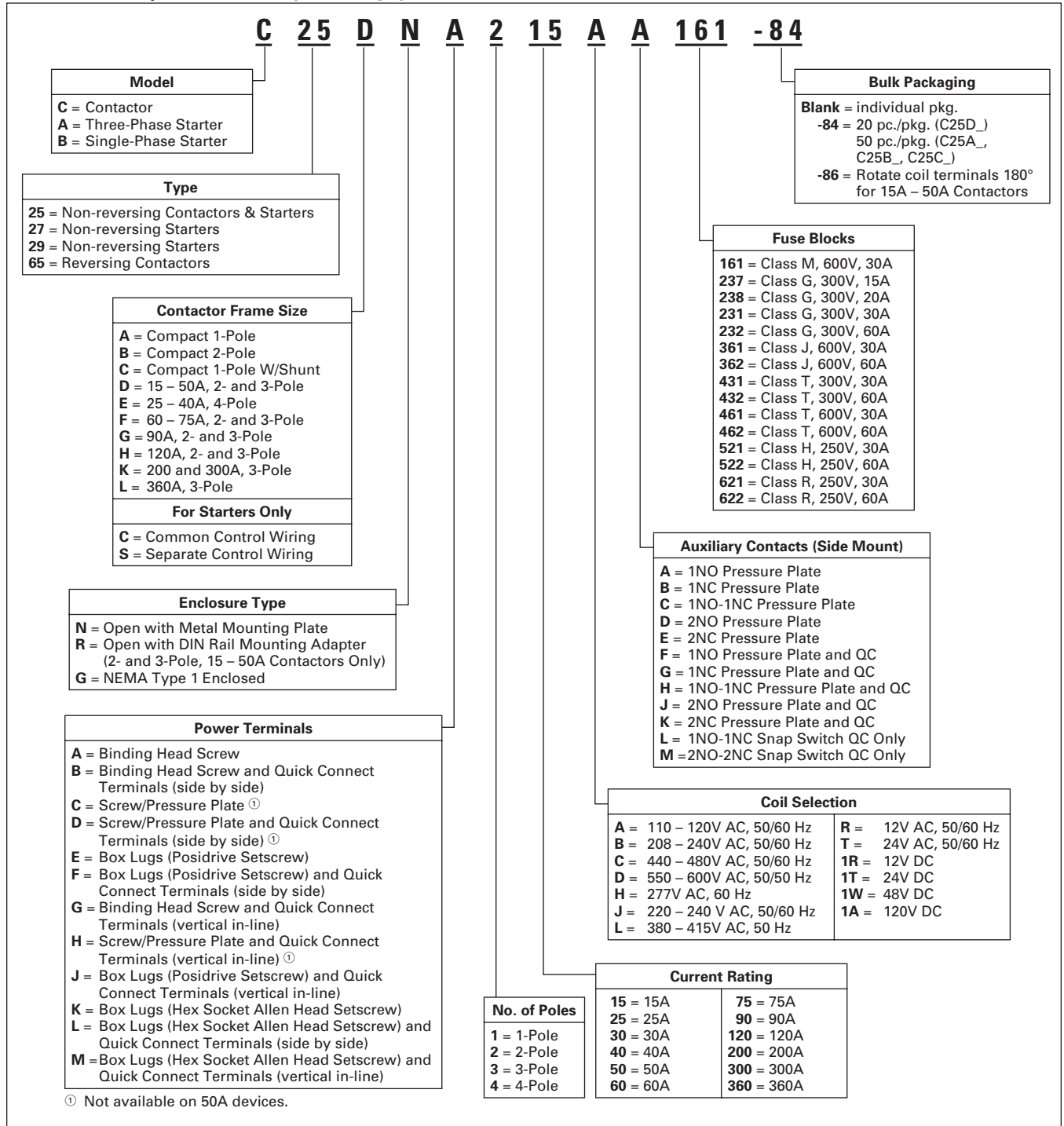

Contents

Description	Page
Compact 1- and 2-Pole Contactors 20 – 40A	
Product Description	2
Standards and Certifications	2
Technical Data — Specifications	2
Options	2
Dimensions	3
Product Selection	3



Compact 2-Pole

Product Description

Cutler-Hammer® 20 – 40A, single- and double-pole, Type C25 contactors from Eaton’s electrical business feature a compact, efficient design with a low VA coil and straight-through wiring. New contactor housing design effectively limits dust and other contaminants from magnet structure — reduces or eliminates noise. These economically priced, UL recognized/CSA certified, ampere rated devices are well suited for use in heating/air conditioning, refrigeration, data processing and food service applications.

Standards and Certifications

- UL Recognized Components: UL File Number E1491, Guides NLDX2 and NLDX8
- CSA Certified Components: CSA C22.2 No. 14-05, File Number 238083 Class 3211 84
- IEC 60947-4-1
- EN 60947-4-1
- ARI 780/790 Standard
- RoHS Compliance



Technical Data — Specifications

- Insulation Voltage: 690V
- Current Rated and hp/kW Rated
- Contacts: Double Break
- Magnet Coil: Class F, 155°C
- Contact Arc Covers are standard on all Contactors
- Standard Power Terminals —
 - 5/16" Hex Washer Head Screws
 - Quad (4) Quick Connect Terminals on all Line and Load Terminals
 - Box Lugs available as option
- Contactors are marked with Line and Load Terminal Designations
- Operating Temperature Range: -13 to 158°F (-25 to 70°C)
- Terminal Wire Range —
 - Hex Washer Head Screws: 16 – 10 AWG, 30 lb-in torque rating
 - Box Lugs: 16 – 10 AWG, 35 lb-in torque rating; 8 AWG, 40 lb-in torque rating; 6 – 4 AWG, 45 lb-in torque rating
- Mounting Position: Vertical, Horizontal or Tabletop

Table 2. Coil Characteristics

AC Coil Voltage 50/60 Hz	Max. Inrush VA	Max. Sealed VA	Max. Sealed Watts
One-Pole			
24	33	6	2
120	33	6	2
208/240	33	6	2
277	33	6	2
Two-Pole			
24	41	6.5	3
120	41	6.5	3
208/240	41	6.5	3
277	41	6.5	3
480	41	6.5	3

Options

Table 3. Compact Options — Factory Installed

Description	*
Box lugs with quick connects for 20 – 40A contactors:	
1-Pole	
1-Pole with shunt	
2-Pole	
To order replace letter in the 6th position of Catalog Number with letter F. EXAMPLE: C25BNF240A	

Discount Symbol **1CD-5C**
* Consult Sales Office for Pricing

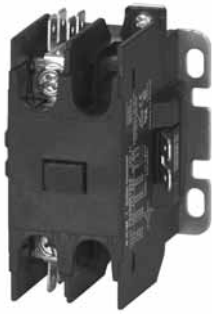

Compact 1-Pole



Compact 1-Pole with Shunt



Compact 2-Pole

Product Selection

When Ordering Specify

- Catalog Number plus Magnet Coil Suffix.
- Modify Catalog Number for any options required — see factory installed Options **Page 2**.

Table 4. Catalog Numbering System

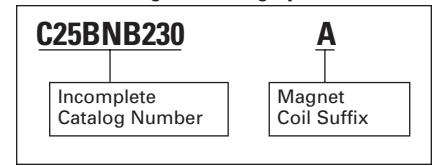

Table 5. Compact Contactors Product Selection— Open Type

Ampere Ratings ①					Max. Motor Horsepower		Max. Motor Kilowatts		Catalog Number ②③	*
Inductive Full Load	Resistive	Locked Rotor			115V	230V	115V	230V		
		240 – 277V	480V	600V						
Single-Pole										
25	30	150	50	40	2	3	1.5	2.2	C25ANB125_	
30	40	150	75	50	2	5	1.5	3.7	C25ANB130_	
40	50	240	200	160	3	7-1/2	2.2	5.5	C25ANB140_	
Single-Pole with Shunt										
25	30	150	50	40	2	3	1.5	2.2	C25CNB125_	
30	40	150	75	50	2	5	1.5	3.7	C25CNB130_	
40	50	240	200	160	3	7-1/2	2.2	5.5	C25CNB140_	
Double-Pole										
20	30	120	100	80	1-1/2	3	1.1	2.2	C25BNB220_	
25	35	150	125	100	2	3	1.5	2.2	C25BNB225_	
30	40	150	125	100	2	5	1.5	3.7	C25BNB230_	
40	50	240	200	160	3	7-1/2	2.2	5.5	C25BNB240_	

① Rating per pole.

② Incomplete Catalog Number. Replace underscore (_) in Catalog Number with Coil Suffix letter from **Table 6**.

③ Bulk pack quantities are available in quantities of 50, contact local sales office.

Table 6. Magnet Coil Selection

AC Coil Voltage 50/60 Hz	Coil Suffix
24	T
110 – 120	A
208 – 240	B
277	H
380 – 415 (50 Hz); 440 – 480 (60 Hz)	C

Dimensions

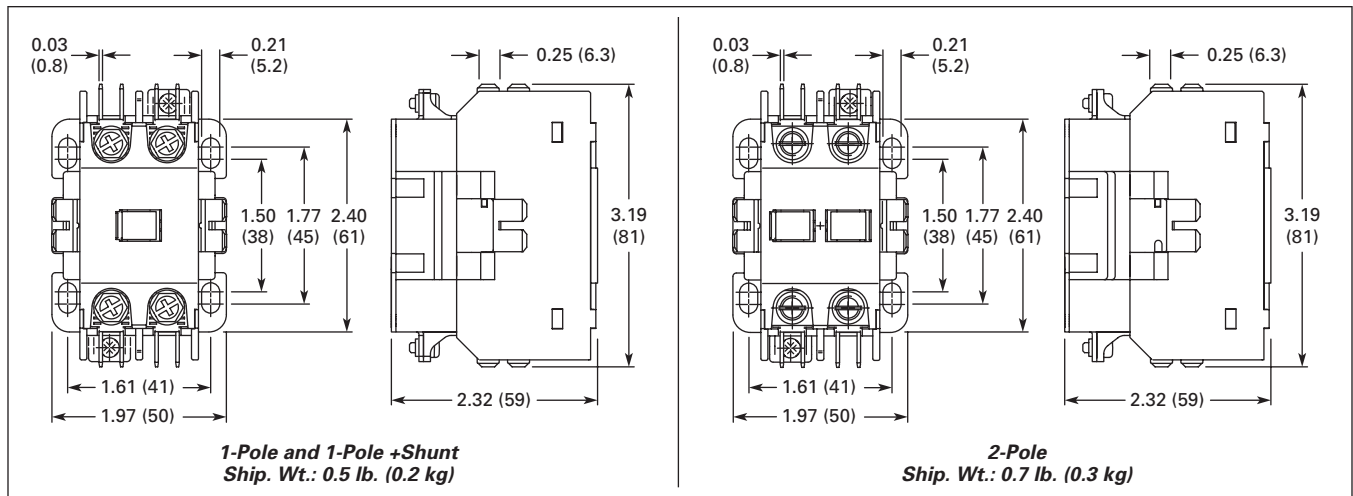

Figure 1. Compact Approximate Dimensions in Inches (mm) and Shipping Weights

Technical Data **Page 2**
 Options **Page 2**
 Discount Symbol **1CD-5C**

* Consult Sales Office for Pricing



50 mm DP Contactor

Product Description

Cutler-Hammer® Type C25 Definite Purpose Contactors 15A through 360A, from Eaton's electrical business incorporate most competitive contactor mounting dimensions into a single baseplate. Contactors are dual-rated with inductive and resistive ratings as well as horsepower and kilowatt ratings. C25 contactors are furnished with pressure plates and quick connect terminals as standard on 15, 25 and 30A devices and with box lugs and quick-connect terminals on 40, 50, 60 and 75A. Other terminal configurations are available, see **Table 14**. Contactors will accept add-on auxiliary contacts — order factory assembled or as kits for field installation.

The separately available snap-on mechanical interlock permits interlocking two contactors for reversing or two-speed applications.

Contactors rated 15 – 50A only are available with DIN rail mount as a factory installed option.

Standards and Certifications

- UL Recognized Components
UL File #E-1491, Guide NLDX2
- CSA Certified Components
File #LR353, Class 3211 04, 481301 & 122201
- IEC 60947-4-1
- EN 60947-4-1



- RoHS Compliance (15A to 50A Only)



Technical Data and Specifications

- Magnet coil:
 - Class B (C25E, F, G, H and K), 130°C
 - Class F (C25D and L), 155°C
 - Class H (C25D), 180°C (Available as factory installed option)

- Contacts: Double break
- Coil terminals: 10 – 14 AWG
- Ambient temperature: 150°F (65°C) maximum
- UL recognized, CSA certified and conform to ARI 780
- CE mark
- Terminal wire range:
 - #8–32 binding head screw:
14 – 12 AWG (one conductor-solid)
 - #8–32 screw/pressure plate:
 - 14 – 8 AWG (one conductor)
 - 14 – 8 AWG (two conductors)
 - Box lugs — 15 – 50A:
 - # 2 posidrive screw or 5/32 hex socket screw
 - Upper Level: 14 – 4 AWG (one conductor)
 - Lower Level: 14 – 6 AWG (one conductor)

- Box lugs — 60 – 75A
 - Upper Level: 14 – 2 AWG
 - Lower Level: 14 – 6 AWG

Note: The box lugs on the 15 – 75A device can accept two conductors per pole.

- Box lugs — 90A: 1/0 – 14 AWG
- Box lugs — 120A: 3/0 – 8 AWG
- Box lugs — 200 – 300A: 350 MCM – 6 AWG
- Box lugs — 360A: 750 MCM – 2 AWG

Table 7. Lighting Duty Ratings (25A to 50A Only)

C25D_ Inductive Rating	Tungsten & Ballast (480V)
25A	30A
30A	40A
40A	50A
50A	60A

Table 8. IEC/CE Ratings (IEC 60947-4-1, EN 60947-4-1) for 15A through 50A C25D_ Contactors

C25D_ Inductive Rating	AC-1 (Ic)		AC-3 (Ie)		AC-4 (Ie)		AC-8a	
	480V	600V	480V	600V	480V	600V	480V	600V
15A	20A	20A	15A	15A	15A	—	15A	15A
25A	30A	30A	25A	25A	25A	—	25A	25A
30A	40A	40A	30A	30A	30A	—	30A	30A
40A	50A	—	40A	—	40A	—	40A	—
50A	65A	65A	50A	50A	50A	—	50A	50A

Table 9. DC Ratings (15A to 50A Only)

Voltage	2-Pole, 15 – 30A Inductive			2-Pole, 40A Inductive			3-Pole, 15 – 30A Inductive			3-Pole, 40A Inductive		
	UL/CSA		DC-3/DC-5	UL/CSA		DC-3/DC-5	UL/CSA		DC-3/DC-5	UL/CSA		DC-3/DC-5
	FLA	hp	I _e	FLA	hp	I _e	FLA	hp	I _e	FLA	hp	I _e
240V DC 3 Poles in Series	—	—	—	—	—	—	4	3/4	4	5	1	5
120V DC 3 Poles in Series	—	—	—	—	—	—	8	3/4	8	10	1	10
120V DC 2 Poles in Series	5.5	1/2	5.5	8	3/4	8	5.5	1/2	5.5	8	3/4	8
120V DC per Pole	2	1/10	2	3.5	1/4	3.5	2	1/10	2	3.5	1/4	3.5
24V DC per Pole	15	—	15	20	—	20	15	—	15	20	—	20

Table 10. Contactor Torque Ratings

Contactor Size	Terminal	Wire Range	Tightening Torque
15 – 50A ①	8–32 Binding Head Screw	12 – 14 AWG	22 lb-in
	Screw/Pressure Plate	8 – 14 AWG	15 lb-in
	Box Lug	12 – 14 AWG 10 AWG 8 AWG 4 – 6 AWG	15 lb-in 25 lb-in 40 lb-in 45 lb-in
60 – 75A ②	Box Lug	10 – 14 AWG 8 AWG 3 – 6 AWG	40 lb-in 45 lb-in 50 lb-in
90A	Box Lug	1/0 – 14 AWG	60 lb-in
120A	Box Lug	8 AWG 4 – 6 AWG 3 – 1/0 AWG	40 lb-in 45 lb-in 50 lb-in
200 – 300A	Box Lug	6 – 350 MCM	200 lb-in
360A	Box Lug	2 – 750 MCM	550 lb-in

① The box lugs on the 15 – 50A device can accept 2 conductors per pole, the upper section will accept 4 – 14 AWG and the lower section will accept 6 – 14 AWG.

② The box lugs on the 60 – 75A device can accept 2 conductors per pole, the upper section will accept 3 – 14 AWG and the lower section will accept 6 – 14 AWG.

Product Selection

When Ordering Specify

- Catalog Number plus Magnet Coil Suffix, below.

- Modify Catalog Number for any options required — see Options, Page 6.

- Catalog Numbers of accessory kits required, Page 6.

Table 11. Catalog Numbering System

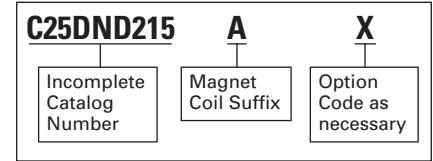

Table 12. C25 Contactors Product Selection— Open Type

Rating, Amperes				Maximum Motor Horsepower		Maximum Motor Kilowatts		Number of Poles	Open Type with Metal Mounting Plate		Open Type with DIN Rail Adapter	
Inductive Full Load	Resistive per Pole	Line Voltage	Locked Rotor	1-Phase	3-Phase	1-Phase	3-Phase		Catalog Number ①②	*	Catalog Number ①②	*
15	20	115	90	3/4	—	0.40	—	2	C25DND215_		C25DRD215_	
		230	90	2	3	1.5	2.2	3				
		460	75	—	5	—	3.7	—				
		575	60	—	5	—	3.7	—				
25	35	115	150	2	—	1.5	—	2	C25DND225_		C25DRD225_	
		230	150	3	7-1/2	2.2	5.5	3				
		460	125	—	10	—	7.5	4				
		575	100	—	10	—	7.5	—				
30	40	115	180	2	—	1.5	—	2	C25DND230_		C25DRD230_	
		230	180	5	10	3.7	7.5	3				
		460	150	—	15	—	11	4				
		575	120	—	15	—	11	—				
40	50	115	240	3	—	2.2	—	2	C25DNF240_		C25DRF240_	
		230	240	7-1/2	10	5.5	7.5	3				
		460	200	—	20	—	15	4				
		575	160	—	20	—	15	—				
50	65	115	300	3	—	2.2	—	2	C25DNJ250_		C25DRJ250_	
		230	300	10	15	7.5	11	3				
		460	250	—	30	—	22	—				
		575	200	—	30	—	22	—				
60	75	115	360	5	—	3.7	—	2	C25FNF260_		NA	
		230	360	10	20	7.5	15	3				
		460	300	—	40	—	30	—				
		575	240	—	40	—	30	—				
75	90	115	450	5	—	3.7	—	2	C25FNF275_		NA	
		230	450	15	20	11	18.5	3				
		460	375	—	50	—	37	—				
		575	300	—	50	—	37	—				
90	120	115	540	7-1/2	—	5.7	—	2	C25GNF290_		NA	
		230	540	20	30	15.1	22	3				
		460	450	—	50	—	37	—				
		575	360	—	50	—	37	—				
120	140	230	720	—	—	—	—	3	C25HNE3120_		NA	
		460	720	—	—	—	—	—				
		575	570	—	—	—	—	—				
200	200	240	1200	—	—	—	—	3	C25KNE3200_		NA	
		480	1200	—	—	—	—	—				
		600	1000	—	—	—	—	—				
300	300	240	1800	—	—	—	—	3	C25KNE3300_		NA	
		480	1800	—	—	—	—	—				
		600	1500	—	—	—	—	—				
360	360	240	2320	—	—	—	—	3	C25LNE3360_		NA	
		480	2320	—	—	—	—	—				
		600	1900	—	—	—	—	—				

- ① Incomplete Catalog Number. Replace underscore (_) in Catalog Number with Magnet Coil Suffix from table below.
- ② Carton quantities including 20 individually packaged units are available for 2- and 3-pole units through 60A inductive.
- ③ Contactors with DC coils (only available up to 75A) include an early break NC auxiliary contact, C320KGD1. See Page 33 for more details.
- ④ Available only for 15A through 75A contactors and 4-pole contactors.
- ⑤ Available through 75A.
- ⑥ Available through 120A.
- ⑦ Available 120 – 360A.
- ⑧ Available 15 – 90A, others 240V.
- ⑨ Available through 50A.

Table 13. Magnet Coil Selection

Voltage		Coil Suffix	
60 Hertz	50 Hertz		
AC ①			
12 ⑤	12	R T A E B J H L C D	
24 ⑥	24		
110 – 120 ⑧	110 – 120 ⑧		
208 ⑦	—		
208 – 240 ⑧	208 – 240		
240 ⑨	220		
277	—		
—	380 – 415		
440 – 480	440 – 480		
550 – 600	550 – 600		
DC ③			
12	1R		
24	1T		
48	1W		
120	1A ④		

- ⑩ 104 – 120V 50/60 Hz for 60A, 75A and all 4-Pole Contactors (25A – 40A).
- ⑪ Class H AC Coils available as option for 15A – 50A Contactor. Add 2 before AC Coil Suffix letter.

Technical Data..... Pages 4, 34
 Options Page 6
 Accessories..... Page 6
 Dimensions..... Page 30
 Discount Symbol 1CD-5C

* Consult Sales Office for Pricing

Options — Factory Installed

To order C25, C65, A25 and B25 Contactors and Starters with the factory installed options listed below, change the basic Catalog Number listed in the Product Selection Table as noted.

Table 14. Factory Installed Options

Description	Code Letter	Number of Poles	*
Terminals — 15A through 50A			
Binding Head Screws			
Without Quick Connect Terminals	A	2-, 3-, 4-Pole	
With Quick Connect Terminals (Side-by-Side)	B	2-, 3-, 4-Pole	
With Quick Connect Terminals (Vertical In-Line)	G	2-, 3-Pole	
Screw/Pressure Plate ②			
Without Quick Connect Terminals	C	2-, 3-, 4-Pole	
With Quick Connect Terminals (Side-by-Side)	D	2-, 3-, 4-Pole	
With Quick Connect Terminals (Vertical In-Line)	H	2-, 3-Pole	
Box Lugs			
(#2 Posidrive/Slotted Screw)			
Without Quick Connect Terminals	E	2-, 3-, 4-Pole ①	
With Quick Connect Terminals (Side-by-Side)	F	2-, 3-, 4-Pole ①	
With Quick Connect Terminals (Vertical In-Line)	J	2-, 3-Pole	
Box Lugs (Hex Socket Allen Head Screw)			
Without Quick Connect Terminals	K	2-, 3-Pole	
With Quick Connect Terminals (Side-by-Side)	L	2-, 3-Pole	
With Quick Connect Terminals (Vertical In-Line)	M	2-, 3-Pole	
Terminals — 60A through 75A			
Replace letter in the 6th position of Catalog Number with Code Letter listed below. EXAMPLE: Change C25FNF250 to C25FNE250.			
Box Lugs (Slotted Screw)			
Without Quick Connect Terminals	E	2-, 3-Pole	
With Quick Connect Terminals	F	2-, 3-Pole	

① 4-Pole contactors have box lugs with slotted screws.
 ② Screw/Pressure Plate terminals are not available on 50A Contactors.

Auxiliary Contacts (Side Mount)

Table 15. Auxiliary Contacts — Factory Installed

Add Code Letter listed below to complete Catalog Number. EXAMPLE: Change C25DND215A to C25DND215AA.						
Description	With Standard Pressure Plate Terminals		With Quick Connect Terminals		Snap Switch Design with Quick Connect Terminals	
	Code Letter	*	Code Letter	*	Code Letter	*
For 15 through 90A ③						
1NO	A		F		—	
1NC	B		G		—	
1NO-1NC	C		H		—	
2NO	D		J		—	
2NC	E		K		—	
For 15 through 75A						
1NO-1NC	—		—		L	
2NO-2NC	—		—		M	
For 120 through 360A						
1NO	A		—		—	
1NO-1NC	C		—		—	
2NO	D		—		—	
2NC	E		—		—	

Special Marking

Special contactor marking, consult local sales office.

③ 90A available only with binding head screw and quick connect terminals.

Accessories

Auxiliary Contact Kits (Side Mounted)

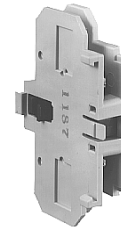

Side Mounted Auxiliary Contact

Table 16. Heavy-Duty Pilot Rated for 10A at 600V AC

Circuit	With Standard Pressure Plate Terminals		With Pressure Plate and Quick Connect Terminals	
	Catalog Number	*	Catalog Number	*
For 15 through 75A				
1NO	C320KG1		C320KG11	
1NC	C320KG2		C320KG12	
1NO-1NC	C320KG3		C320KG13	
2NO	C320KG4		C320KG14	
2NC	C320KG5		C320KG15	
For 90A				
1NO	—		C320DPG10	
1NC	—		C320DPG01	
1NO-1NC	—		C320DPG11	
2NO	—		C320DPG20	
For 120 through 360A				
1NO	C320KGS20		—	
1NC	C320KGS21		—	
1NO-1NC	C320KGS22		—	



Side Mounted Snap Switch

Table 17. Snap Switch Design Side Mounted Auxiliary Contacts

Circuit	Snap Switch Design with Quick Connect Terminals	
	Catalog Number	*
1NO-1NC 2NO-2NC	C320SNP11 C320SNP22	

Discount Symbol **1CD-5C**

* Consult Sales Office for Pricing

Magnet Coil Quick Connect Terminal

Table 18. Magnet Coil Quick Connect Terminal

Description	*
Extra Dual Quick Connect Terminals (U-shaped) for Magnet Coil Terminals ①	

① To order, add Suffix Number 9 to the complete Catalog Number. Example: C25DND215A9.

Auxiliary Contact Kits (Top Mounted)

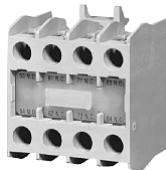

*Top Mounted
Auxiliary Contact*

Table 19. Heavy-Duty Pilot Rated for 10A at 600V AC

Circuit	With Standard Pressure Plate Terminals	
	Catalog Number	*
For 15 through 75A ②		
1NO 1NC	C320KGT1 C320KGT2	
1NO-1NC 2NO 2NC	C320KGT3 C320KGT4 C320KGT5	
3NO 2NO-1NC 1NO-2NC 3NC 4NO	C320KGT9 C320KGT10 C320KGT11 C320KGT12 C320KGT13	
3NO-1NC 2NO-2NC 1NO-3NC 4NC	C320KGT14 C320KGT15 C320KGT16 C320KGT17	

② Not available for 4-pole contactors (15 – 40 Amp).

Mechanical Interlock Kit



*Mechanical
Interlock*

Table 20. Mechanical Interlock Kit for 15 through 75A

Catalog Number	*
C321KM60B	

Solid-State ON DELAY Timer



*Solid-State
ON DELAY Timer*

Side Mounted on C25D, C25E and C25F Frame

This timer is designed to be **wired in series with the load** (typically a coil). When the START button is pushed (power applied to timer), the ON DELAY timing function starts. At the completion of the set timing period, timer and series wired load will both be energized.

Table 21. Solid-State ON DELAY Timer

Timing Range	Catalog Number ③④⑤	*
.1 – 1.0 Seconds 1 – 30 Seconds 30 – 300 Seconds 5 – 30 Minutes	C320TDN1_ C320TDN30_ C320TDN300_ C320TDN3000_	

③ Add operating voltage Suffix to Catalog Number. A = 120V, B = 240V, E = 208V

④ Rated .5 ampere pilot duty — not to be used on larger contactors.

⑤ Terminal connections are quick connects only. Two per side.

Separate Enclosures



*NEMA 1 Enclosure —
Cat. No. C799B19*

Table 22. Separate Enclosures — NEMA 1

Application	Catalog Number	*
15 through 50A, 2- and 3-Pole	C799B18	
60A, 2- and 3-Pole or 25 through 40A, 4-Pole	C799B19	

Discount Symbol **1CD-5C**

* Consult Sales Office for Pricing

15 – 40A, 3-Pole Fuse Block

Optional 3-Pole Fuse Block

Available only on 3-Pole, 15 – 50A Contactors

Designed to save space and reduce installation costs, these 3-pole Fuse Blocks will accommodate a variety of fuse classes and fuse holders to satisfy a wide range of electrical/electronic applications such as commercial space and water heaters, dishwashers, food coolers and sterilizing equipment. They are supplied either factory assembled, mounted and wired to the contactor or in kit form.

To order factory assembled, add Suffix Number from table below to Catalog Number of contactor listed on **Page 5** and make necessary price addition. EXAMPLE: C25DND325A361.

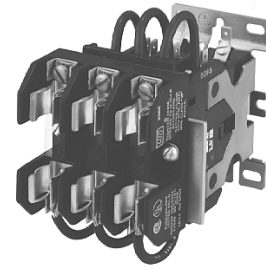

3-Pole Fuse Block

Table 23. 3-Pole Fuse Block

Fuse Holder		Fuse Dimensions in Inches (mm)		Terminal Type and Maximum Wire Size		Factory Installed Ordering Suffix	Field Installation Kit Catalog Number	*
Volts	Amperes	Diameter	Length					
Class M								
600	30	0.41 (10.4)	1.50 (38.1)	Pressure Plate	10 AWG Cu	161	C350KM61	
Class G								
600	15	0.41 (10.4)	1.31 (33.3)	Pressure Plate	10 AWG Cu	237	C350KG37	
	20		1.41 (35.8)	Pressure Plate	10 AWG Cu	238	C350KG38	
480	30	0.41 (10.4)	1.63 (41.4)	Pressure Plate	10 AWG Cu	231	C350KG31	
	60		2.25 (57.2)	Box Lug	2 AWG Cu/Al	232	C350KG32	
Class J								
600	30	0.81 (20.6)	2.25 (57.2)	Pressure Plate	10 AWG Cu	361	C350KJ61	
	60	1.06 (26.9)	2.38 (60.5)	Box Lug	2 AWG Cu/Al	362	C350KJ62	
Class T								
300	30	0.41 (10.4)	0.88 (22.4)	Box Lug	6 AWG Cu	431	C350KT31	
	60	0.56 (14.2)	0.88 (22.4)	Box Lug	2 AWG Cu/Al	432	C350KT32	
600	30	0.56 (14.2)	1.50 (38.1)	Box Lug	6 AWG Cu	461	C350KT61	
	60	0.81 (20.6)	1.56 (39.6)	Box Lug	2 AWG Cu/Al	462	C350KT62	
Class H								
250	30	0.56 (14.2)	2.00 (50.8)	Pressure Plate	10 AWG Cu	521	C350KH21	
	60	0.81 (20.6)	3.00 (76.2)	Box Lug	2 AWG Cu/Al	522	C350KH22	
Class R								
250	30	0.56 (14.2)	2.00 (50.8)	Pressure Plate	10 AWG Cu	621	C350KR21	
	60	0.81 (20.6)	3.00 (76.2)	Box Lug	2 AWG Cu/Al	622	C350KR22	

Dimensions

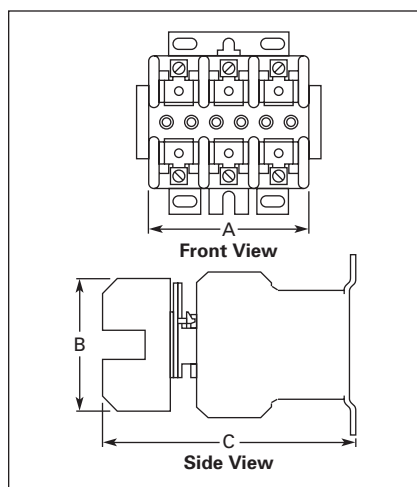

Figure 2. 3-Pole Fuse Block and Contactor Dimensions

Table 24. Approximate Dimensions for 3-Pole Fuse Block and Contactor

Fuse Size			Dimensions in Inches (mm)		
Class	Amps	Volts	Wide A	High B	Deep C
For Dimensions Not Shown, See Next Page.					
G	15	600	2.41 (61)	2.81 (71)	5.14 (131)
	20		2.41 (61)	2.81 (71)	5.14 (131)
	30	480	2.41 (61)	2.81 (71)	5.14 (131)
	60		2.62 (67)	4.25 (108)	5.18 (132)
H	30	250	3.00 (76)	3.03 (77)	5.33 (135)
	60		4.22 (107)	4.75 (121)	5.86 (149)
J	30	600	4.81 (122)	4.12 (105)	5.92 (150)
	60		4.81 (122)	4.12 (105)	5.92 (150)
M	30	600	2.41 (61)	2.81 (71)	5.14 (131)
R	30	250	3.00 (76)	3.03 (77)	5.33 (135)
	60		4.22 (107)	4.75 (121)	5.86 (149)
T	30	300	3.44 (87)	2.75 (70)	5.43 (138)
	60	300	3.44 (87)	2.75 (70)	5.43 (138)
	30	600	3.75 (95)	3.19 (81)	5.36 (136)
	60	600	4.87 (124)	2.94 (75)	5.68 (144)

Discount Symbol **1CD-5C**

* Consult Sales Office for Pricing